

DECINA

DISCOVER INDULGENCE

NOVARA CONNECTOR TOILET SUITE INSTALLATION & OWNER GUIDE

Thank you for purchasing a Decina Novara Toilet Suite .

This manual provides the correct steps and care advice for a safe and long lasting installation.

The Novara adjustable connector toilet suite toilet is a flexible, economic choice for bathroom renovations, particularly where a longer set-out is required, as the pan can be fitted away from the cistern, linked by a flush pipe. Featuring a soft close lid and dual flush buttons, the Novara's smooth outer design, reduces any dust collecting & makes cleaning easier.



NOTSCOS 632-825 (d) x 350 (w) x 855 (h) (mm)

THIS PRODUCT MUST BE INSTALLED BY A QUALIFIED TRADESMAN



- ❗ Before installing your new toilet, unpack & check the item is correct & not damaged. If there are any visible defects do not proceed with the installation & contact the place of purchase immediately. Any claims for damage will not be accepted after installation.
- ❗ If the product has not been installed in accordance with AS/NZS 3500.1 and AS/NZS 3500.2 instructions, the warranty will be invalidated.
- ❗ Make sure the water supply valve is shut off before installation.
- ❗ Check that the toilet is compatible with your current set out requirements. This toilet has a concealed s-trap set out of 140-255mm.
- ❗ If a longer set-out is required, pan can be fitted away from the cistern, linked by a flush pipe.
- ❗ Check that the floor and wall are level and perpendicular.
- ❗ Remove any old bolts, silicon, putty etc from base area.
- ❗ This product is configured for bottom right or left hand entry. For rear entry you need to purchase a rear entry kit (sold separately).

TOILET SUITE INCLUSIONS

- Toilet cistern
- Toilet pan
- Toilet seat cover
- Connector plate
- Flush accessories
- Flush pipe
- Fixing screws

SAFETY EQUIPMENT REQUIRED FOR INSTALLATION



Protective Clothing



Foot Protection



Eye Protection



Hand Protection

TOOLS REQUIRED FOR INSTALLATION



Drill

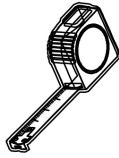

Tape Measure

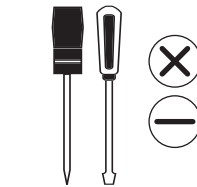

Screwdrivers



Rubber Mallet



Pencil



Adjustable Wrench

INSTALLATION STEPS

STEP 1.

Seat installation

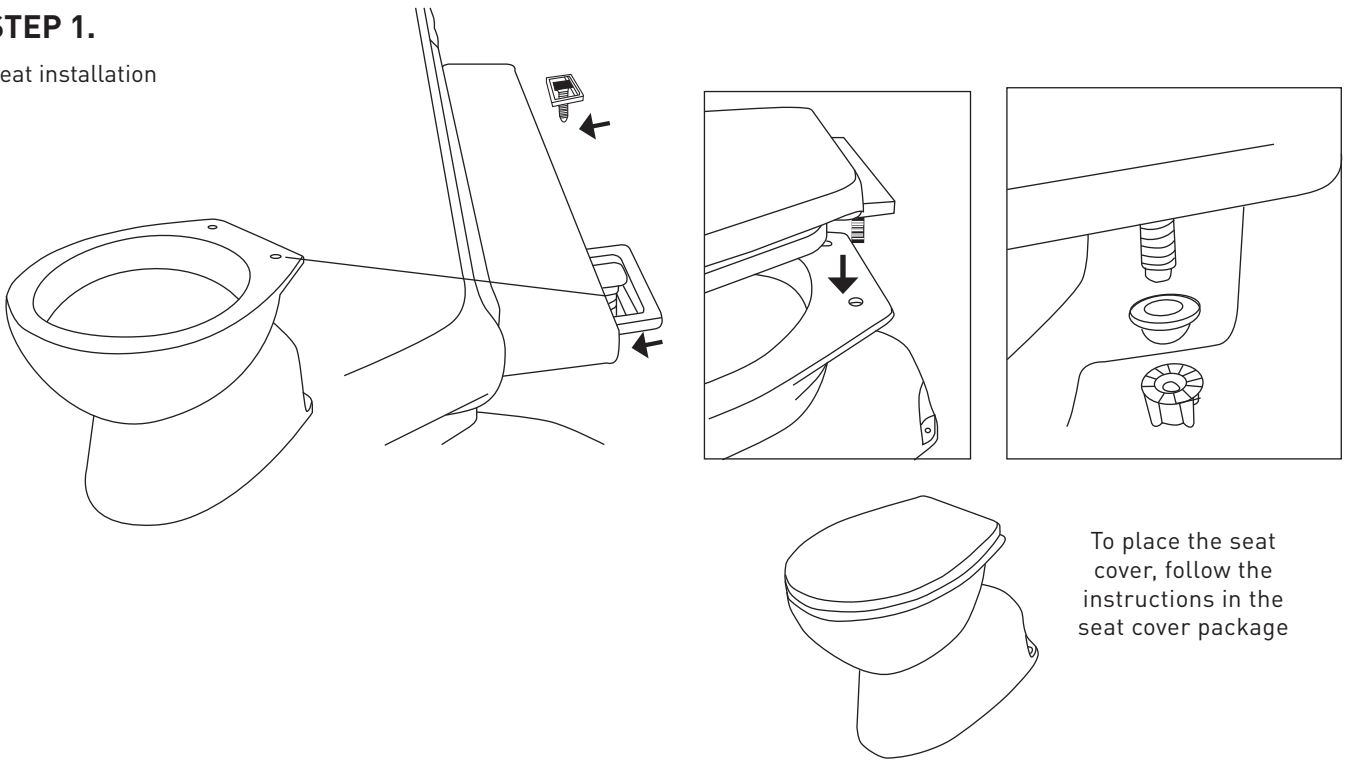

STEP 2.

Flush accessories installation

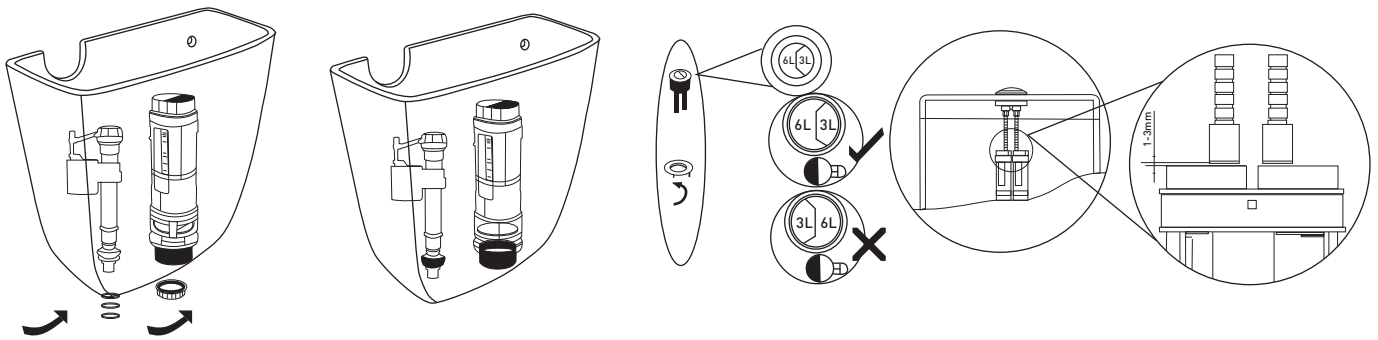

STEP 3.

Wall-hung cistern location fixing holes

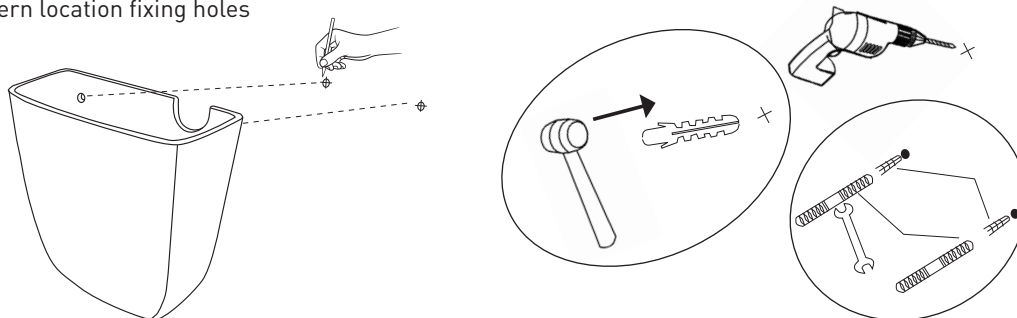

INSTALLATION STEPS

STEP 4.

Wall-hung cistern installation

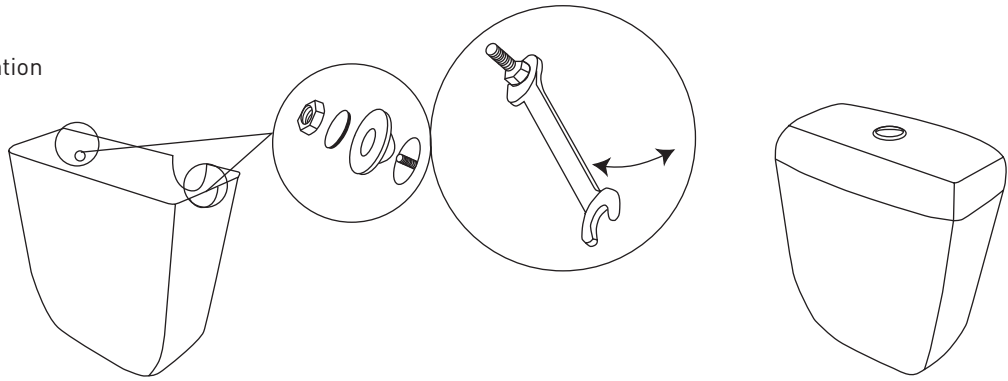

STEP 5.

Connector plate & flush pipe (cut to required length)

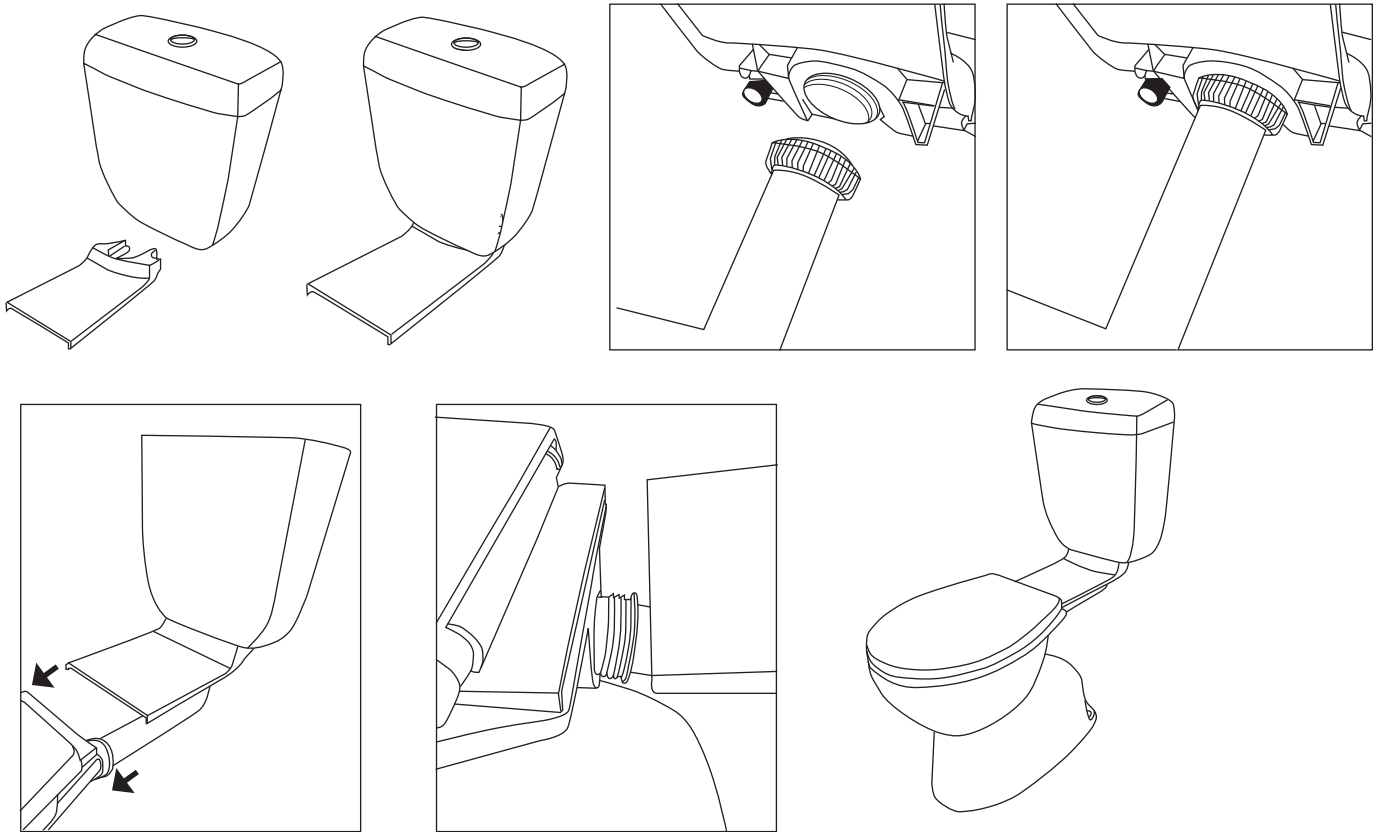

STEP 6.

Screw mounting for pan

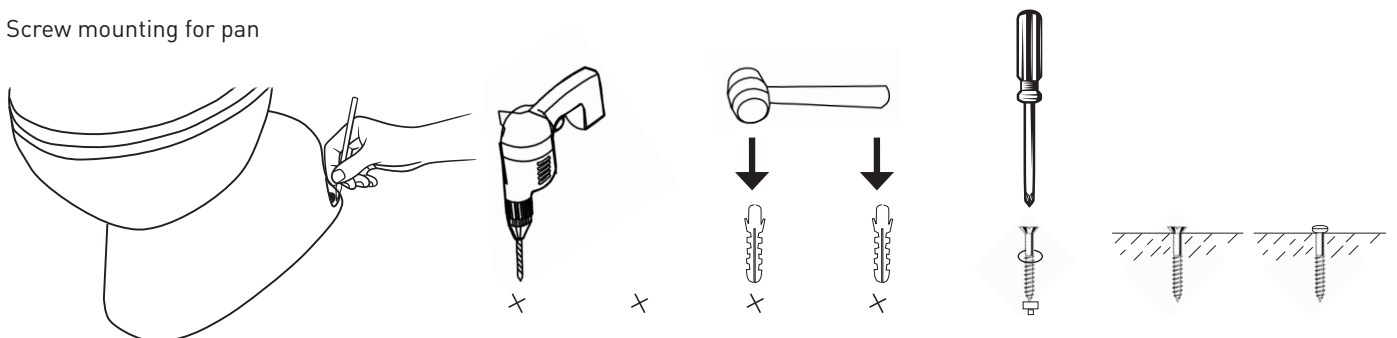

MAINTENANCE

To maintain your Decina Toilet Suite for the longest possible period we recommend it is cleaned with a mild household detergent or warm soapy water and a soft cloth. Abrasive cleaners should be avoided on the toilet seat as this can remove the gloss surface. Ensure the seat hinges and bolts are regularly checked and tightened, as they can loosen over time. Avoid any hot, sharp or hard objects falling on to the plastic seat which can cause scratches and discolouration. The seat is resistant to most household products but some chemical products such as shave lotion, hair spray, nail polish and remover can stain the toilet seat and must be washed off immediately.

WARRANTY TERMS & CONDITIONS

All Decina products are manufactured to the highest standards and guaranteed to be free of defects, subject to the conditions outlined below. In addition to the statutory rights given under Australian Consumer Law, Decina offers the following extended warranty periods from the date of purchase or handover:

PARTS	WARRANTY	TERMS
Vitreous China Cistern & Pan	5 Years / 1 Year	Replacement products / Parts & labour
Seat, lid & hinges	1 Year	Replacement products or parts
Button assembly	1 Year	Replacement products or parts
Internal systems (valves)	1 Year	Replacement products or parts

Parts subjects to wear and tear i.e. Seals and rubbers are not covered by Warranty.

The Decina warranty is only applicable when the product has been installed by a qualified tradesman, in full accordance with the installation instructions and statutory requirements. The warranty specifically EXCLUDES damages discovered AFTER installation.

Decina's responsibility for claims relating to impact damage ceases within 48 hours after delivery to the Decina re-seller's store.

The extended warranties only apply to faults or defects in the product arisen solely from faulty materials or workmanship in the products and does not apply to other defects for example from; damage, abuse, neglect or changes to the product supplied.

The warranty only extends to the supply of a replacement product or credit to the value of the purchase and excludes consequential damage ensuing from the product application or use. The responsibility for the removal and replacement of the product is with the installer and/or owner. Where the manufacturer "Decina" accepts that the product is at fault, the maximum contribution to the removal and replacement costs will be \$500.

Repairs of the Products other than by a Decina accredited or licensed service agent or technician are not covered.

In addition to this extended warranty, certain legislation (including the ACL) may give you certain rights which cannot be excluded, restricted or modified, this extended warranty must be read subject to such legislation and nothing in this warranty has the effect of excluding, restricting or modifying those rights.

To make a warranty claim, please visit the Decina website decina.com.au/warranty-claim/ or email services@decina.com.au and attach the following documentation:

- Proof of purchase (original invoice from the supplier)
- Details of the warranty claim including the date of installation, installer's details and head contractors
- Your contact details

If the Product has not been installed, please contact Decina to inspect the Product. If the claim is accepted, the Product can be returned or exchanged. Note: The extended warranty only applies to the original owner and is not transferable. Decina reserves the right to charge a service fee for any staff called to attend premises where products have been installed and the warranty claim is not authorised.

Copyright Feb 2019. Decina Bathroomware Pty Ltd. ABN 39845 084 033

PLEASE LEAVE THIS MANUAL WITH THE END USER