

Luna Shower Base and Acrylic Wall **INSTALLATION GUIDE**



DECINA
BATHROOMWARE
relaxing your senses

TABLE OF CONTENTS

- 1 INTRODUCTION
- 2 BENEFITS OF DECINA PRODUCTS
- 3 CONTENTS SUPPLIED
- 4 TOOLS REQUIRED
- 5 PERSONAL PROTECTIVE EQUIPMENT (PPE)
- 6 WARNINGS
- 7 COMPLIANCE REQUIREMENTS
- 8 AREA PREPARATION
- 9 SHOWER BASE SITE PREPARATION
- 10 SHOWER BASE INSTALLATION FOR ACRYLIC WALL APPLICATIONS
- 11 ACRYLIC SHOWER WALL LINER INSTALLATION
 - Drilling Tap Holes in Acrylic Shower Wall Liner
 - Attaching the Acrylic Shower Wall Liner
- 12 SHOWER BASE INSTALLATION FOR TILE WALL APPLICATION
 - Wall Preparation for Timber Stud Wall
 - Wall Preparation for Steel Stud Wall
 - Installation Procedure
- 13 CLEANING & MAINTENANCE
- 14 DECINA WARRANTY

1. INTRODUCTION

Thank-you for purchasing a quality Decina product and supporting an Australian owned company directly employing over 100 people. This product has been manufactured to meet our quality assurance standards and in accordance with the following Australian Standards.

- AS3588/1996
- AS1288/2006

This comprehensive installation guide is designed to help make the installation of your shower products easy and clarifies all necessary information to be correctly installed.



2. BENEFITS OF DECINA PRODUCTS

Luna Shower Bases

Decina's newly developed range of Luna Shower Bases feature the latest trends in modern shower designs including:-

- Made in Australia
- Low profile designer shower base
- Lucite acrylic sanitary grade sheet
- Self supporting feet for ease of installation
- Friction lock high strength removable waste cover
- Easy clean waste
- Available with left or right hand tile bead

Decina Shower Walls

- Made in Australia
- Lucite acrylic sanitary grade sheet
- 2000mm height
- Unidirectional fit



3. CONTENTS SUPPLIED

Luna Shower Base / Pack contains

- 1 x Shower Base
- 1 x Shower Waste

Shower Wall Liner / Pack contains

- 1 x Shower Wall Liner
- 3 x Sika® Showerbond Adhesive
- 1 x Clear Anti-Fungal Silicon

IMPORTANT NOTE:

Only use adhesive or silicon supplied by Decina and follow the instructions on each product.

Ensure the “use-by” date is current. Warranty may be void if these points are not adhered to.

4. TOOLS REQUIRED



Masking Tape



Soft Pencil



Knife



Hole Saw
(to suit tapware)



Tape Measure



Drill & Drill Bit

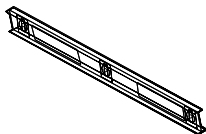

Spirit Level

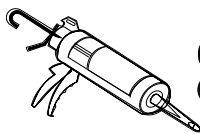

Caulking Gun
(+ Building Adhesive)

5. PERSONAL PROTECTIVE EQUIPMENT (PPE)

For the safety of the installer, the following items should be used during the installation of Decina products.



a) Protective Clothing



b) Protective Eyewear



c) Protective Gloves



d) Protective Footwear



e) Protective Earwear - whilst using power tools

f) Any other items listed by the manufacturer of the adhesives or sealants used during this installation

6. WARNINGS



- a) Installation of Decina Products MUST be carried out by a QUALIFIED TRADESPERSON.
- b) Inspect the product and all components (listed) PRIOR TO INSTALLATION.
- c) Installation of damaged goods will VOID your Warranty
- d) Decina acrylic products shall not be used directly adjacent to any direct heat source above 70 degrees Celsius, as this may cause distortion of the product.
- e) Decina acrylic products will expand and contract with temperature changes, so it is important to allow expansion gaps where shown in this instruction.
- f) Decina Acrylic products may have sharp edges, so always wear appropriate protective clothing and footwear during the installation process.

7. COMPLIANCE REQUIREMENTS

Any wet area installation or renovation must comply with the following:-

BUILDING CODE OF AUSTRALIA

Volume One - Class 2 - 9 Buildings

Volume Two - Class 1 and Class 10 buildings - Housing Provisions

- BCA 2006 Volume One references AS 3740 - 'Waterproofing of wet areas in residential buildings' as meeting the minimum performance requirements for construction of wet areas in Class 2, 3 and 4 buildings.
- BCA 2006 Volume Two gives detailed waterproofing requirements for various applications. These requirements are for all intents and purposes the same as those provided in AS 3740.

AUSTRALIAN STANDARD AS 3740 - 2010

Waterproofing of Domestic Wet Areas

This standard specifies the requirements for the physical elements of construction including floors, walls, junctions and penetration and the specific areas where these criteria apply including showers.

8. AREA PREPARATION

- To ensure correct installation of Decina Shower products, it is important to have the site floor and walls; level; square and plumb to within 5mm overall.

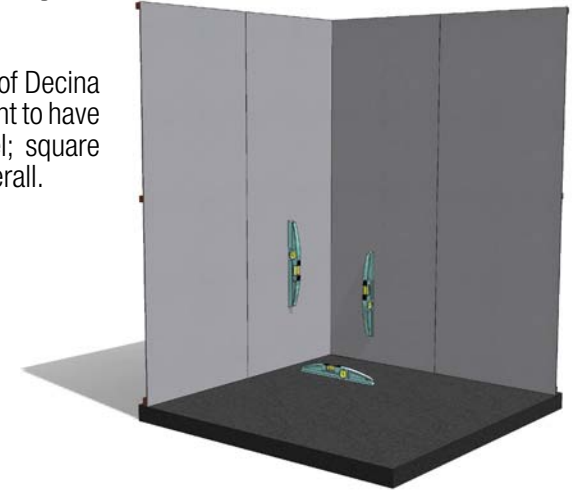

To not do so may prevent correct fitment of a Decina glass shower screen system onto the Decina Luna Shower Base or tiles and may affect water drainage of the shower base.

- To ensure proper bond of the Decina Shower products, the floor and wall area must be smooth, clean, dry, unpainted and UNSEALED.
- For Decina **Acrylic Shower Wall Liner** applications, installation shall only be on NEW wall lining WETBOARD, to ensure and effective bond of the adhesives and sealants.
- All floor and wall surface joints and fixings must be flush to prevent unevenness on the Decina shower products, potentially causing stress points or unsightly bulges.
- Decina Shower Base and Acrylic Shower Wall Lining products must be fitted to a structurally sound solid surface that does not flex under load. This will prevent unevenness in the product or potential weak spots.

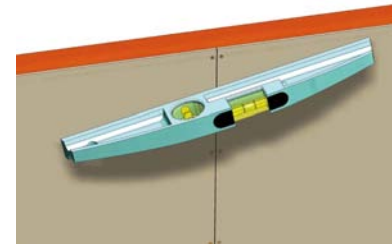

9. SHOWER BASE SITE PREPARATION

- Decina Luna Shower Bases DO NOT require installation on a cement slurry mortar base, as they are fitted with SELF-SUPPORTING FEET.
- To ensure proper drainage of water to the waste and also for correct installation of an optional Decina Glass Shower Screen, the floor area under the Luna Base must be flat and level to within 2mm over the width of the proposed base installation area.
- For concrete floor installations, if the floor installation area is uneven or unlevel, the floor should be relevelled using a cement based self levelling compound (eg. ARDEX L292 or similar as per manufacturer's instructions).
- For timber or panel floor installations, it is necessary to first lay a suitable fibre cement floor underlay sheet (eg. James Hardie Ceramic Tile Underlay or similar as per manufacturer's instructions). The underlay must be laid level and all fixings set flush with the surface to avoid unevenness.
- Ensure the waste trap hole in the floor is no greater than 200 x200mm and does not encroach on the position of the Decina Luna Shower Base self supporting feet.
- For timber or panel floor installations, ensure the waste trap hole does not result in the weakening of the floor, as the Decina Luna Shower base does not form part of the building integrity. If weakened, the opening should be suitably reinforced to provide a structurally sound and flex resistant floor once complete.

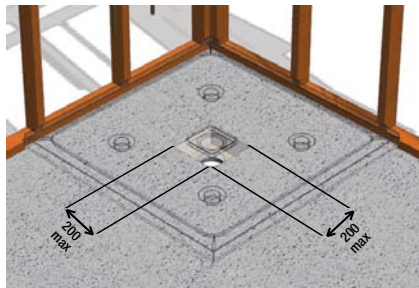
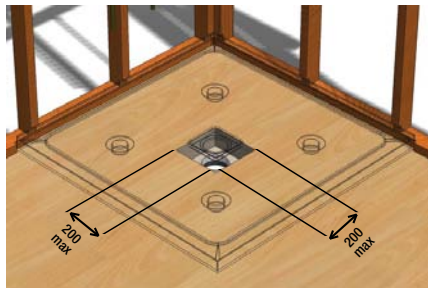
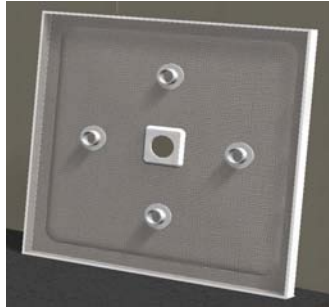

- Before the shower base can be installed, the choice of wall construction and wall lining method must be determined. The choice will determine which of the following methods should be followed:

10. SHOWER BASE INSTALLATION FOR ACRYLIC SHOWER WALL APPLICATIONS

- A** For Acrylic Shower Wall Liner applications the Decina Luna Shower Base does not need checking into the stud wall, but can be simply pushed against the stud frame. The shower base can be installed before the Wetboard sheeting is applied.
- B** If the Shower Base is to be installed after the Wetboard is installed, the wetboard sheet will need to be cut away to allow the base to sit against the stud wall, allowing a 6mm gap all around the shower base.
- C** All Decina Shower Bases are manufactured with a protective film to prevent damage to the surface of the product.
- D** Prior to installation, pull the protective film back from the edges of the shower base (approx 25mm) and completely from the waste area.



DO NOT COMPLETELY REMOVE THE PROTECTIVE FILM AT THIS STAGE

- E** Qualified tradesperson should assemble the waste and adjoining plumbing. The waste assembly should be checked to ensure it's located centrally in the shower base waste hole for best appearance. The locking nut should be kept loose until the Chrome top cover is located and sits centrally in the hole, with equal spacing around all sides. Once satisfied, tighten the lock ring on the waste assembly back and then remove the chrome waste cover until the end of the installation for protection.



- F** Ensure the floor surface is clean and dry. Apply a generous amount of building adhesive to the Shower Base self supporting feet - suitable for concrete bond (adhesive not supplied – eg. Liquid Nails or similar).
- G** Position the Shower Base against the wall studs and push the Shower Base down firmly to bed the feet against the floor. Recheck the Shower Base level and conduct a water test to ensure full drainage to the waste. Relevel the base as required whilst adhesive is still uncured.
- H** Allow the Shower Base to cure for at least 24 hrs as per the adhesive manufacturer's instructions before installing the wall sheeting. This ensures the level will not change by standing on it.
- I** Once the Shower Base bond is fully cured, the Wet area sheeting can be applied over the Shower Base tile bead as per the relevant Wet Board manufacturer's instructions. The Wetboard should sit over the top edge of the tile bead. Ensure the Wetboard is installed at least 6mm above the shower base tile bead for expansion.

- Once sheeting is completed, use a flexible waterproof sealant (not supplied) to seal the gap between the Shower Base tile bead and the Wetboard.

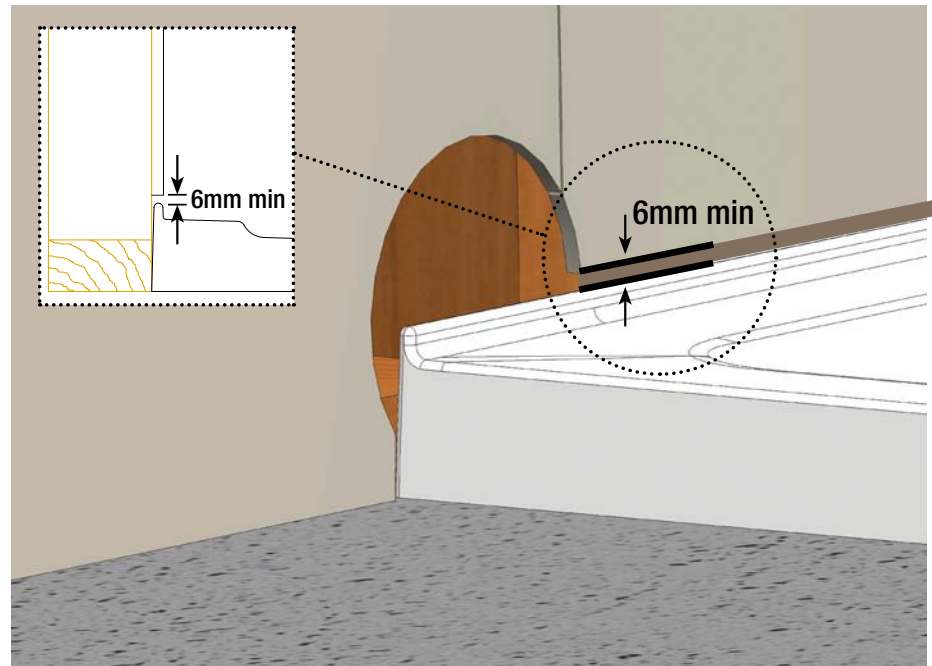
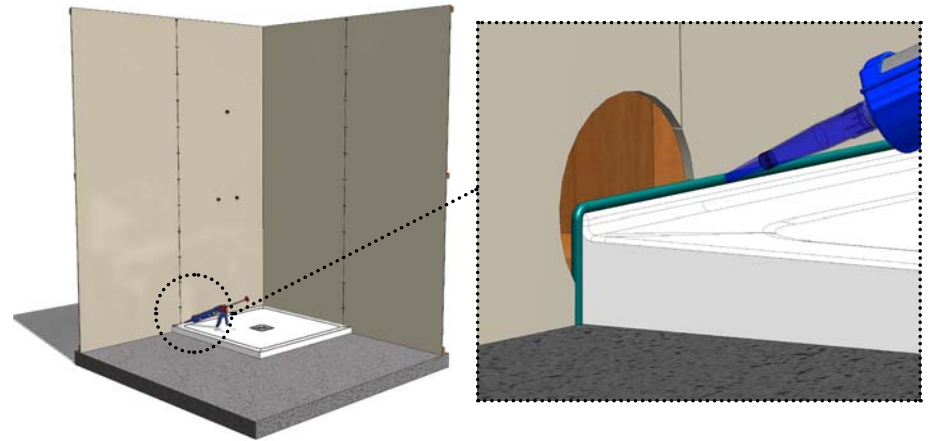

FOR STEEL STUD WALL FRAMES WITH ACRYLIC SHOWER WALL LINING APPLICATIONS - SEE BELOW

- NOTE: As a steel wall stud should not be cut, it is necessary to build out the wall level to clear the Shower Base tile bead thickness.
- A suitable WETBOARD product of no less than 12mm thickness is required to achieve the desired level. Use of either a 13mm Wet Area Plasterboard or 12mm Wet Area Fibre Cement sheet is advised.
- Install the chosen 12 or 13mm WETBOARD product bottom edge at least 6mm above the tile bead (as per relevant manufacturer's instructions).
- Once sheeting is completed, use a flexible waterproof sealant (not supplied) to seal the gap between the Shower Base tile bead and the WETBOARD.

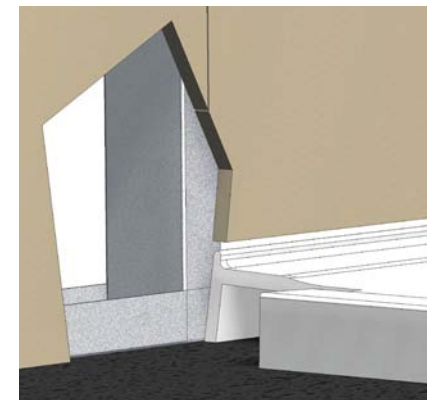

11. ACRYLIC SHOWER WALL LINER INSTALLATION

DRILLING TAP HOLES IN ACRYLIC LINER

- Have a qualified tradesperson install the shower fittings. Mark the position of the holes for the fittings on acrylic shower wall liner.



- Large holes must be drilled with a FINE tooth hole saw.
- Holes should be drilled from the outside show face only

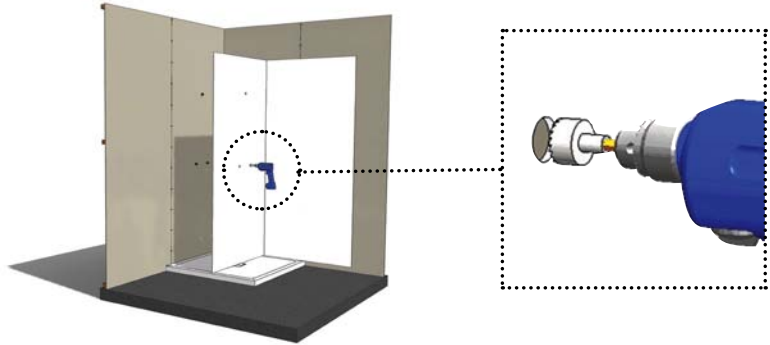

- Ensure all final hole sizes have at least a 2mm clearance around tap fittings for expansion.

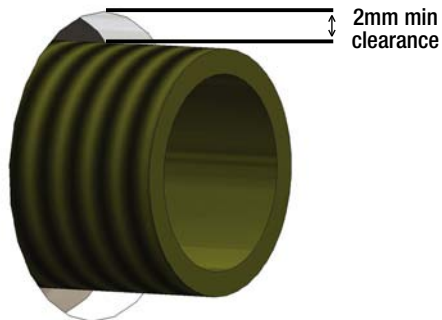

ATTACHING THE ACRYLIC SHOWER WALL LINER

Positioning Shower Wall Liner

- Trial position the shower wall liner against the shower recess, ensuring it fits squarely into the recess corner and shower base.
- Tape the corners with masking tape to hold the liner in position.
- Use a soft pencil to mark around the edges of the shower wall liner before removing.

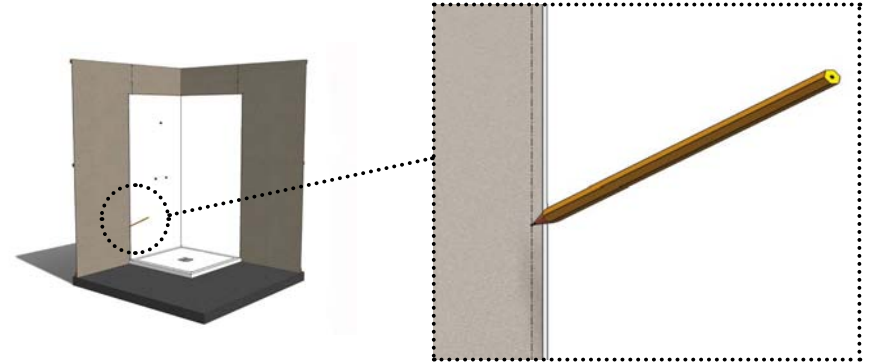

Adhering Shower Wall Liner

- Prepare area by wiping down the shower wall, base and wetboard ensuring it is clean and dry.
- The shower liner is adhered to the wetboard using Sika Showerbond adhesive supplied. ONLY this adhesive should be used on the wall liner, as other brands may fail over time. Please read the manufacturer's instructions on the back of the Showerbond cartridge before use.
- Using the marked pencil lines as your guide and starting from the outside, apply the adhesive as per diagram below. Apply a continuous 5mm bead of adhesive onto the Wetboard, 15mm minimum from the side and bottom edges. DO NOT PUT ANY ADHESIVE ALONG THE TOP EDGE, as this will seal the wall liner and not allow expansion of air to escape during use – causing buckling of the liner.
- Apply a bead of adhesive around the tap fittings, with 15mm clearance on all sides.

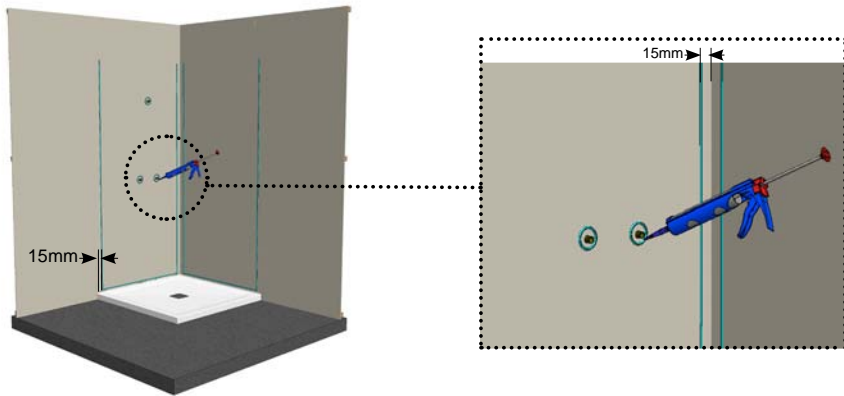

- Apply vertical lines of Showerbond adhesive on the wetboard, 100mm apart to cover the remainder of the wall liner area.

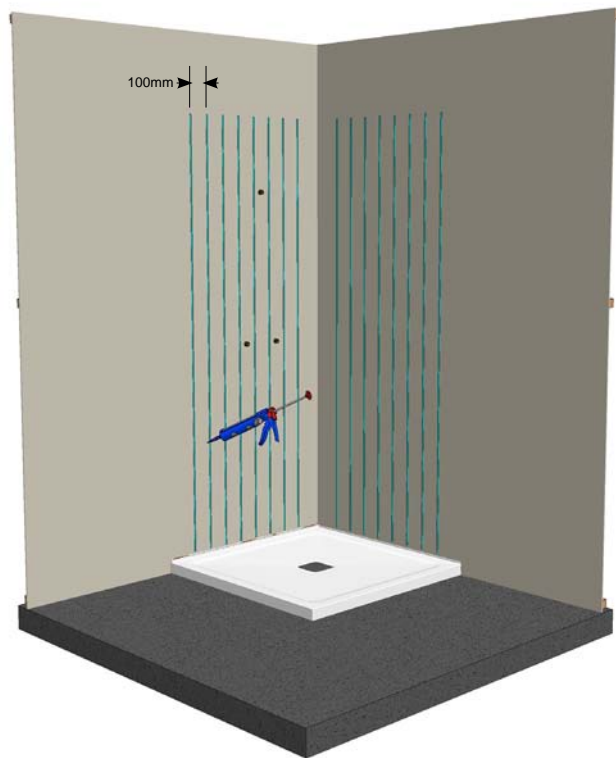

- Before fitting the shower wall liner, apply a bead of silicone sealant supplied along the inside face of the tile bead upstand of the shower base as shown below.

NOTE:
THE SILICON SHOULD NOT BE VISIBLE ONCE THE WALL IS FITTED

NOTE:
Store silicon for use the following day.

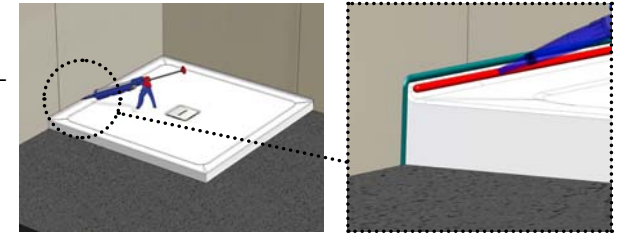

YOU WILL ONLY HAVE 20 MINUTES TO COMPLETE THE GLUEING PROCESS

FIXING SHOWER WALL LINER

- Place the wall lining into position ensuring that the corner area is pressed into place first. Note the bottom edge of the shower wall liner should be sitting hard on the shower base, in front of the tile bead.
- Remove the shower wall liner from position for approximately 5 seconds to allow the adhesive to aerate.
- Reposition the shower wall liner. Use a damp cloth and press towards the edges to ensure full contact has been made over the entire shower liner area.
- Ensure site is left for 20 minutes to cure and then brace as required to hold in position.
- Bracing should remain in position for not less than 18 hours for complete curing.

AFTER INSTALLATION

Once wall lining adhesion is fully cured, remove the protective film on the shower wall liner completely.

- The protective film on the remainder of the Shower Base can also be removed and the Chrome Waste Cover fitted.
- Apply silicone sealant provided around the tap hole penetrations to waterproof the gaps. A qualified tradesperson can now fit the tap sets over the wall liner.
- DO NOT USE THE SHOWER FOR AT LEAST 24 HOURS AFTER FINAL INSTALLATION TO ALLOW FOR FULL CURE.
- Refer to Section 13 for Cleaning and Maintenance Instructions.

12. SHOWER BASE INSTALLATION FOR TILE WALL APPLICATIONS

For tile wall applications it is important that the bottom edge of the wetboard sheet sits in front of the shower base tile bead - the following steps are required to prepare the wall

WALL PREPARATION FOR TIMBER STUD WALL FRAMES ON TILE LINING INSTALLATIONS

- Locate the shower base against the timber stud wall and mark the position of the base along the studs and down the shower base sides at a distance of 10mm greater with a pencil.

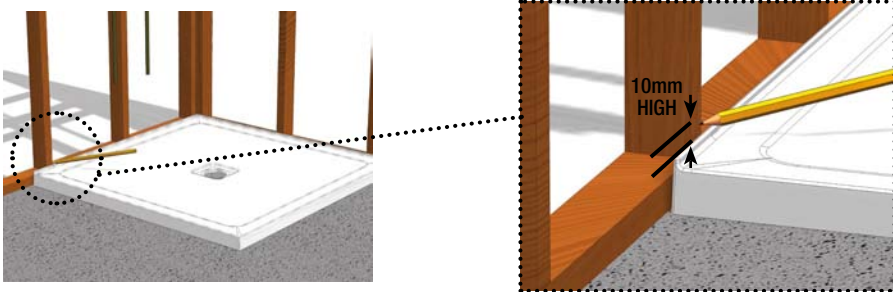

- With a chisel, check out the timber frame to a depth of between 10-15mm. This allows the shower base tile bead to sit behind the final wet board sheeting for waterproofing.

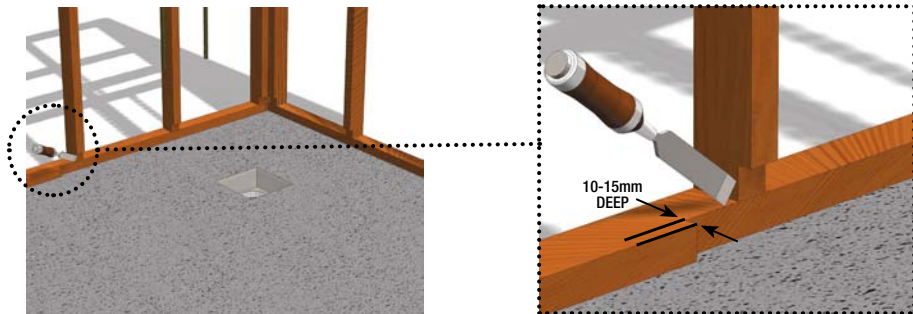

TRAY INSTALLATION FOR TILE WALL APPLICATIONS -

- Refer Steps A - G Section 10
- Allow the Shower Base to cure for at least 24 hrs as per the adhesive manufacturer's instructions before installing the wall sheeting. This ensures the shower base level will not change by standing on it.
- Once the Shower Base bond is fully cured, the Wet area sheeting can be applied over the Shower Base tile bead as per the relevant Wet Board manufacturer's instructions. The Wetboard should sit over the front of the tile bead. Ensure the Wetboard is installed at least 6mm above the shower base floor level for expansion.

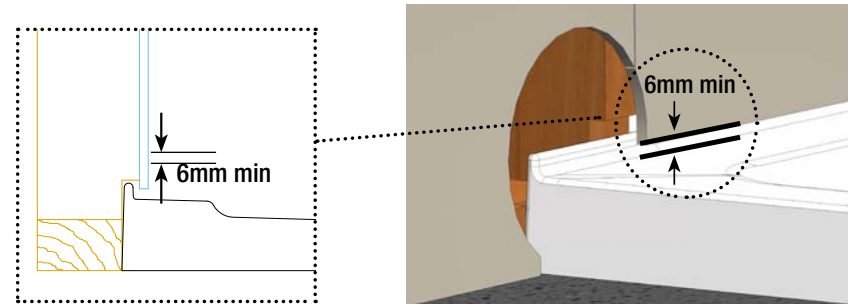

- Once sheeting is completed, use a flexible waterproof sealant (not supplied) to seal the gap between the Shower Base and the Wetboard.

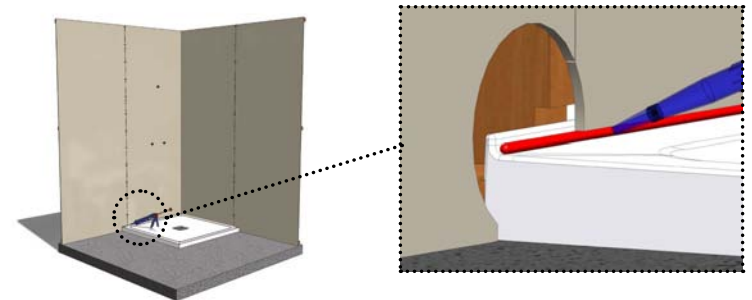



WALL PREPARATION FOR STEEL STUD WALL FRAMES ON TILE WALL INSTALLATIONS - SEE BELOW

- NOTE: As a steel wall stud should not be cut, it is necessary to build out the wall level to clear the Shower Base tile bead thickness. On top of this a thinner 6mm wetboard is installed down inside the tile bead, this will provide support behind the bottom row of tiles. (See instructions below)
- A suitable WETBOARD product of no less than 12mm thickness is required to achieve the desired level. Use of either a 13mm Wet Area Plasterboard or 12mm Wet Area Fibre Cement sheet is advised.
- Install the chosen 12 or 13mm WETBOARD product bottom edge at least 6mm above the tile bead (as per relevant manufacturer's instructions).
- Once completed the final 6mm WETBOARD sheet can be installed onto the 12 or 13mm WETBOARD. Ensure the 6mm WETBOARD is installed at least 5-6mm above the shower base for expansion.
- Once sheeting is completed, use a flexible waterproof sealant (not supplied) to seal the gap between the Shower Base and the 6mm WETBOARD.
- The Shower recess is now ready for tiling. Once tiling is completed, the protective film can be further removed to allow for the shower screen installation. Once the screen installation is complete, the remainder of the protective film can be removed and the Chrome Waste Cover fitted.
- Refer to Section 13 for Cleaning and Maintenance Instructions

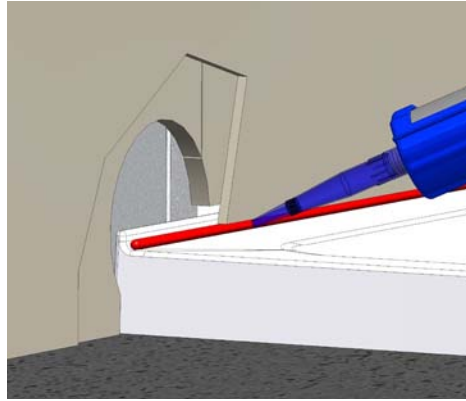

13. CLEANING & MAINTENANCE

If your Luna Shower Base or Shower wall are given the proper care, the lustrous surface of the Lucite sheet will retain its appearance for many years.

It is very easy to clean using clear water with a small amount of detergent or mild soap. Chamois, soft cloth or sponge is suitable for cleaning but cloths must never be used dry.



Do not use window cleaner, benzene, toluene, acetone, methyl ethyl ketone or strong concentrated acids, etc

Do not use abrasive substances and abrasive cleaners.

To remove paint, grease or tar use a good grade of Isopropyl alcohol.

Fine hairline scratches may be minimized by the use of a mild polish such as Brasso, which has a mild abrasive action and tends to fill small scratches to make them less visible.

14. WARRANTY

Decina Bathroomware Pty. Ltd. products carry the following Warranties on Manufacture and Materials:-



Luna Shower Bases



Luna Shower Base Waste



Shower Wall Liner & Shower Screens

Conditions

1. The Decina Warranty shall only apply where the product has been installed by a qualified tradesman and in full accordance with the Installation Instructions and Statutory requirements. The Warranty specifically EXCLUDES damage discovered AFTER installation.
2. Decina's responsibility for claims relating to impact damage shall cease within 48 hours from delivery to the Reseller's store.
3. The Warranty shall only extend to the supply of a replacement product or credit to the value of the purchase and specifically EXCLUDES consequential damage ensuing from the product application or use. The responsibility for the removal and replacement of the product shall be with the installer and/or owner or where the manufacturer accepts that the product is at fault, a maximum contribution to the removal and replacement costs will be \$500. Where the installation requires a relocation of the waste by an offset device, Decina will not offer a warranty against leakage unless a "through" waste connector is used (Recommended brand is Tacron).
4. Colours shown on retail catalogue are indicative only.
5. Decina Bathroomware Pty Ltd reserves the right to vary specifications or delete models from their range without prior notification. As measurements may vary, it is highly recommended that the shower system is on-site before tapware is fitted.

www.decina.com.au



DECINA
BATHROOMWARE
relaxing your senses

	QLD	NSW	VIC	WA/NT	SA	TAS	NTH QLD
TEL	(07) 3271 1944	(02) 9838 4944	(03) 9768 3768	(08) 9242 4766	(08) 8376 6233	(03) 6245 9008	(07) 4771 3400
FAX	(07) 3879 4244	(02) 9838 9055	(03) 9768 3769	(08) 9242 4733	(08) 8376 6211	(03) 6245 9002	(07) 4771 4955

Decina Bathroomware Pty Ltd

ABN 3984 5084 033

www.decina.com.au

© Copyright Decina Bathroomware Pty Ltd 2011

No part of this publication may be reproduced, transmitted in any form or by any means without the prior written permission of the publisher
Decina products are subject to patent and design protection